

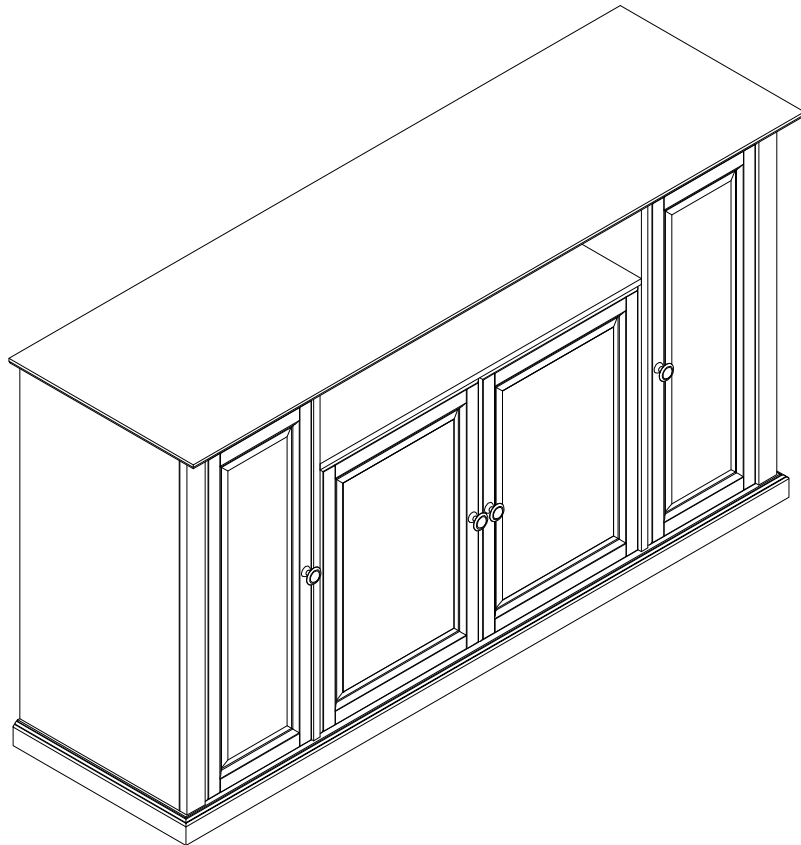

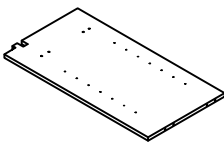

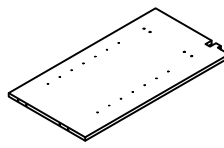

60 " TV Stand Cabinet
CF100160

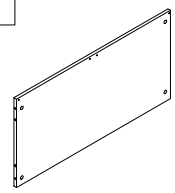
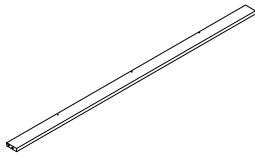
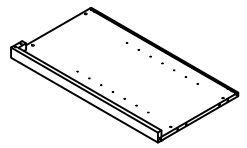
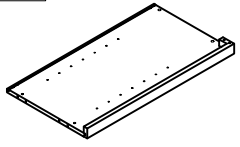
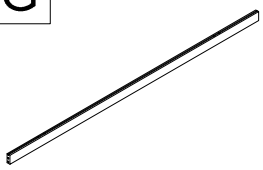
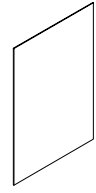
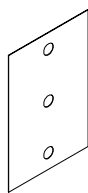

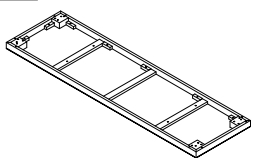
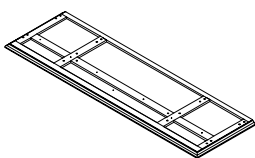
PARTS LIST

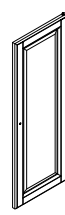
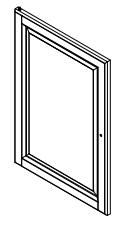
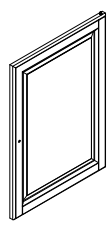
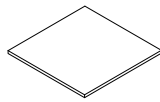
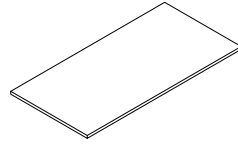
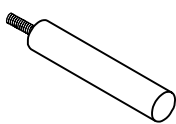
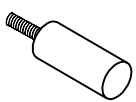
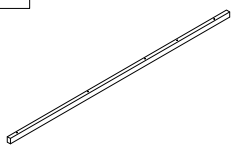
<p>A</p> 	<p>B</p> 	<p>C</p> 	<p>D</p> 	<p>E</p> 
<p>Left Vertical Panel 1 PC</p>	<p>Right Vertical Panel 1 PC</p>	<p>Shelf Panel 1 PC</p>	<p>Front Rail 1 PC</p>	<p>Left Side Panel 1 PC</p>
<p>F</p> 	<p>G</p> 	<p>H</p> 	<p>I</p> 	<p>J</p> 
<p>Right Side Panel 1 PC</p>	<p>Back Rail 2 PCS</p>	<p>Back Panel 2 PCS</p>	<p>Back Panel 1 PC</p>	<p>Back Left Post 2 PCS</p>
<p>K</p> 	<p>L</p> 	<p>M</p> 	<p>N</p> 	<p>O</p> 
<p>Bottom Panel 1 PC</p>	<p>Top 1 PC</p>	<p>Left Door 1 PC</p>	<p>Right Door 1 PC</p>	<p>Left Center Door 1 PC</p>
<p>P</p> 	<p>Q</p> 	<p>R</p> 	<p>S</p> 	<p>T</p>  <p>For use only with Bun Foot</p>
<p>Right Center Door 1 PC</p>	<p>L/R Shelf 4 PCS</p>	<p>Upper Center Shelf 1 PC</p>	<p>Long Round Leg 1 PC</p>	<p>Short Round Leg 1 PC</p>
<p>U</p> 				
<p>Long Bar 1 PC</p>				

HARDWARE LIST

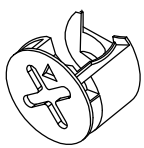
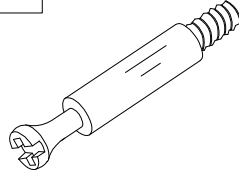
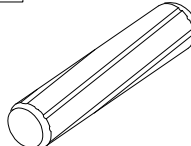
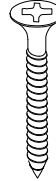
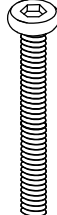
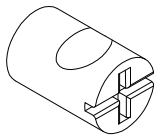
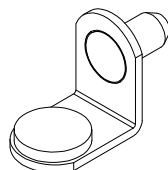
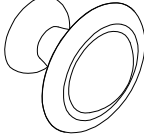
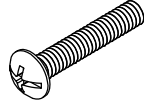
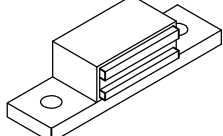
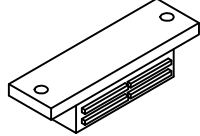
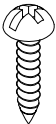
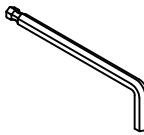
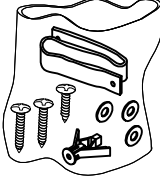
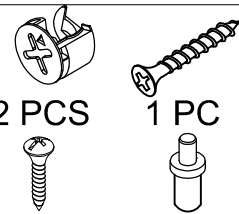
1		2		3		4		5	
	CAM LOCK 20 PCS		CAM BOLT 20 PCS		WOOD DOWEL 42 PCS		SCREW 9 PCS		HEX SOCKET HEAD BOLT 8 PCS
6		7		8		9		10	
	BARREL NUT 8 PCS		SHELF HOLDER 20 PCS		KNOB 4 PCS		ROUND HEAD BOLT 4 PCS		DOOR CATCH 2 PCS
11		12		13		14		 2 PCS 1 PC 1 PC 4 PCS	
	MAGNET 1 PC		ROUND HEAD SCREW 6 PCS		ALLEN KEY 1 PC		SAFETY STRAP KIT 1 PC	EXTRA	

ADDITIONAL TOOLS(Not Provided)

Note:It is not recommended to use power tools during assembly .However a screw gun can assist with mounting

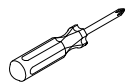

Phillips Head Screw Driver

Step 1. Insert Cam Bolts (part #2) into pre-drilled holes of parts A,B,E,F,K, & L using a Phillips head screw driver.

Note: Do not overtighten cam bolts. Stop tightening once threads on cam bolt are no longer visible.

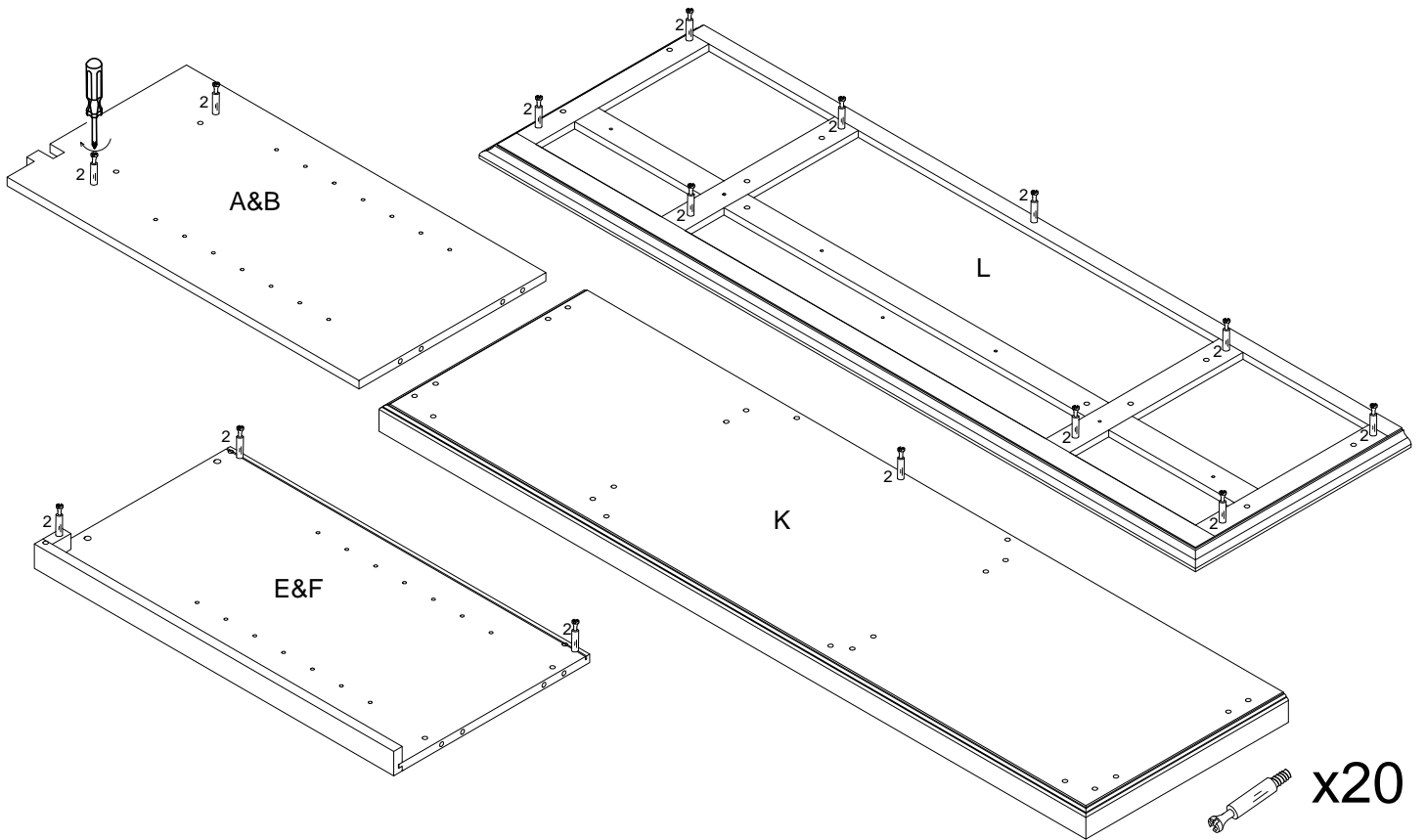

Step 2. Attach panels A & B to shelf C using Cam locks & wood dowels as shown.

Note: Cam locks must rotate full 180. See pictured insert.

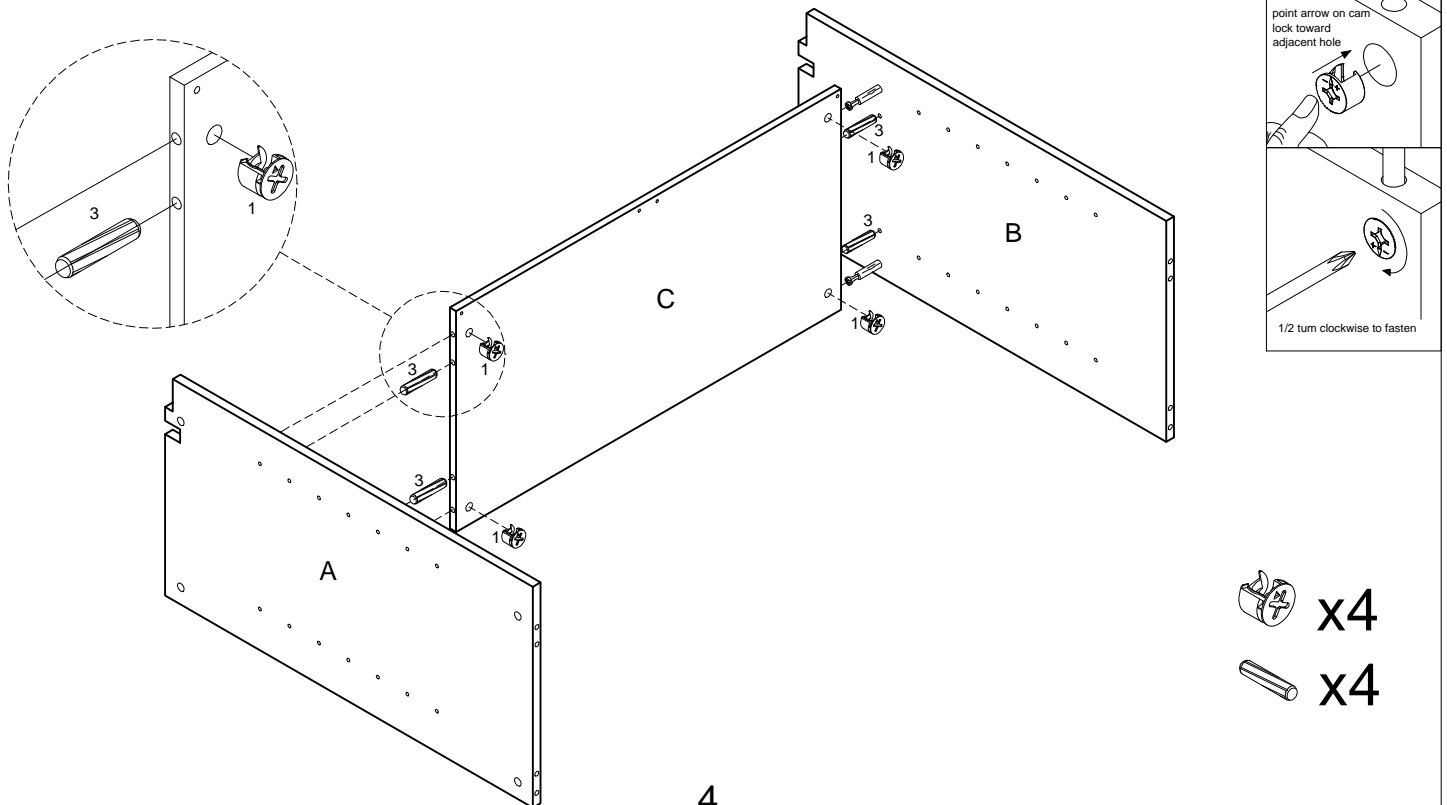

Step 3. Turn assemble parts A,B & C upright with notched cutouts facing upward. Attach Rail D using Wood Screws (part #4) & Wood dowels as shown.

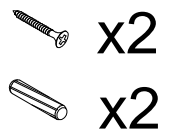
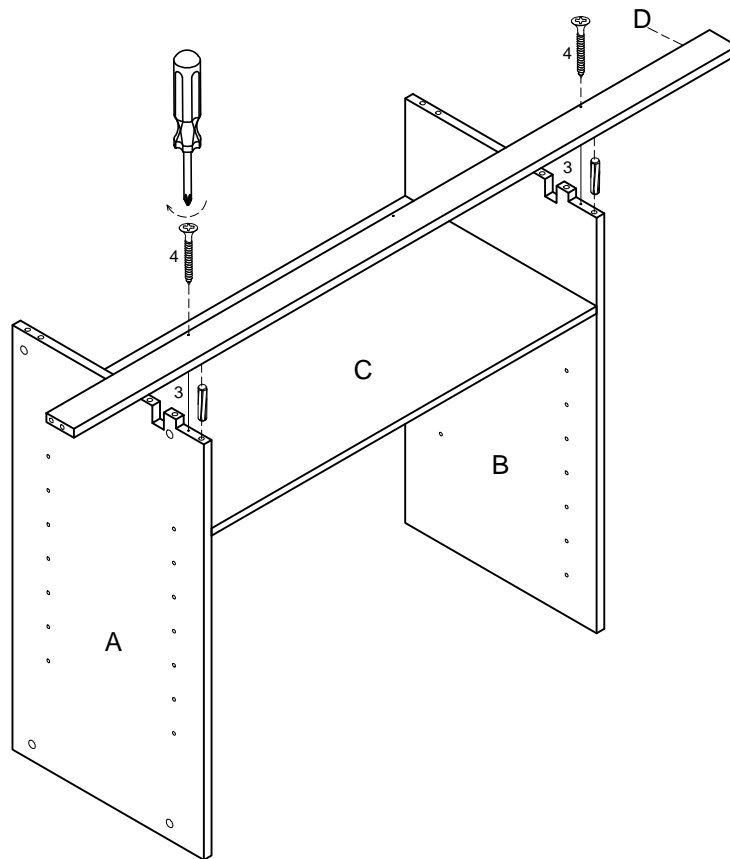

Step 4. Turn unit over with Rail D flat on floor as shown. Attach Panel E to Rail D using Cam lock & Wood dowel as shown

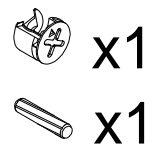
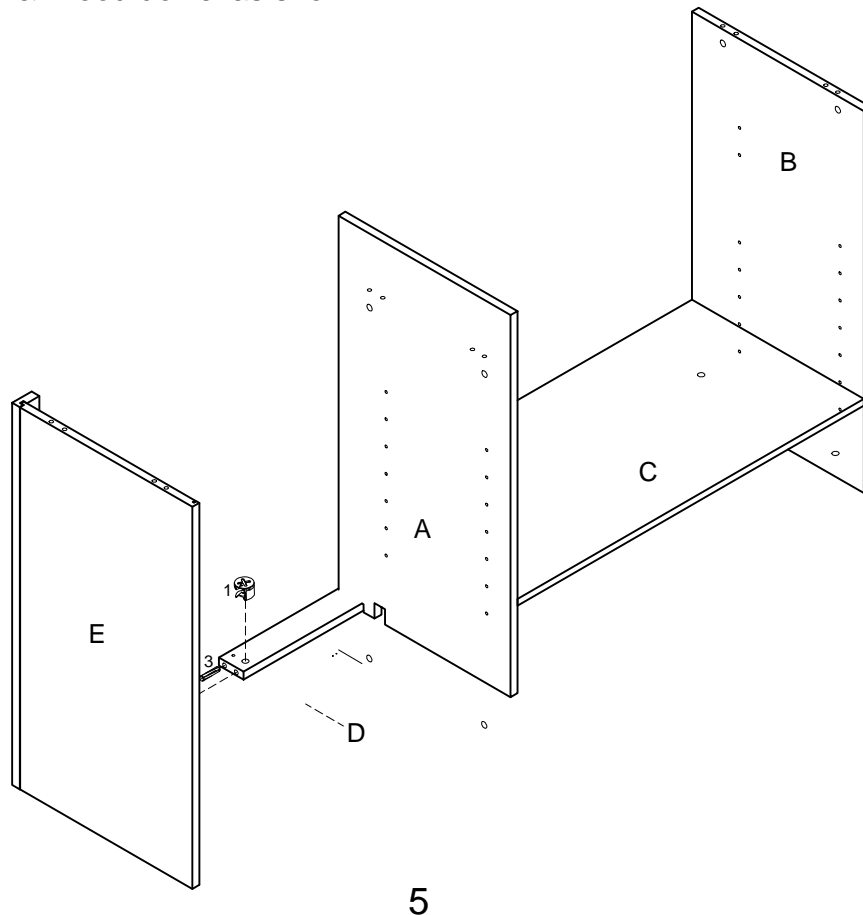

Step 5. Attach Rail G to the unit using Cam lock & Wood dowel as shown.

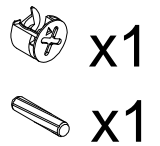
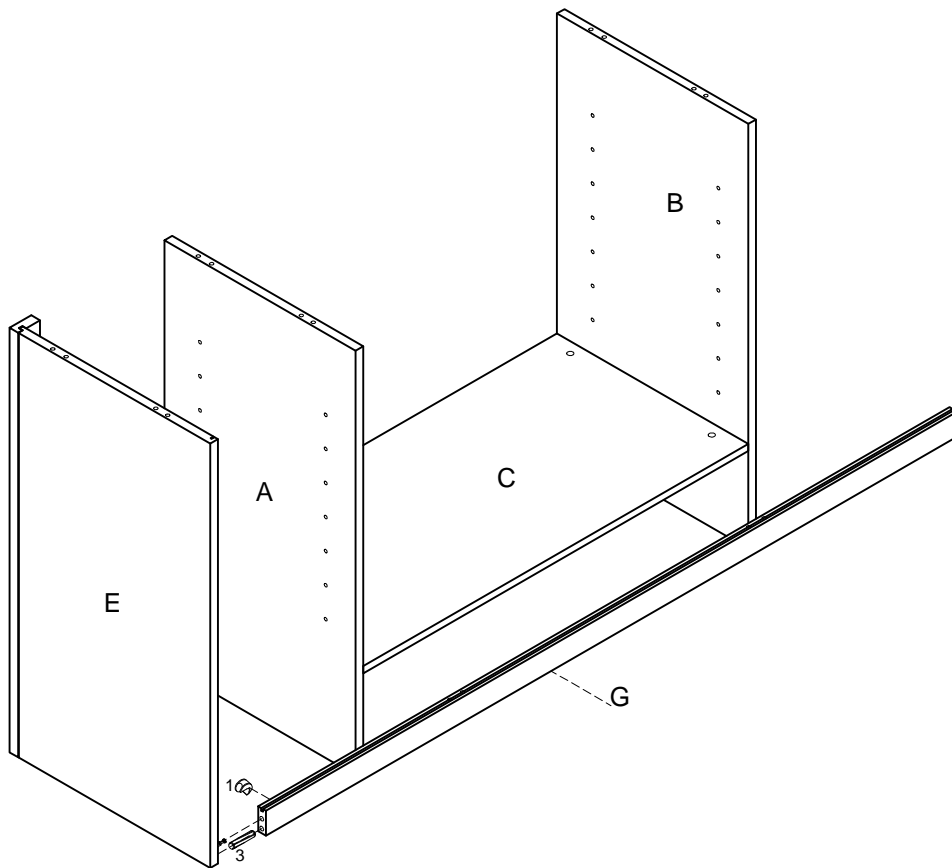



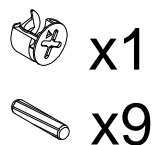
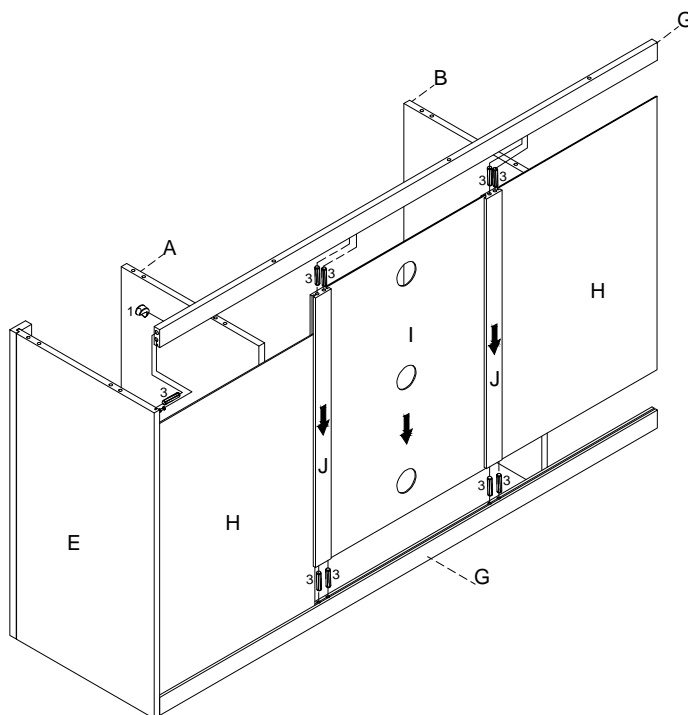

Step 6. Place Rails J into place on Rail G using Wood dowels as shown. Slide Back panels H & Panel I into the grooves as shown. Insert Wood dowels into the top end of Parts J. Attach rail G to Panel E & Rails J using Wood dowels & Cam lock as shown.

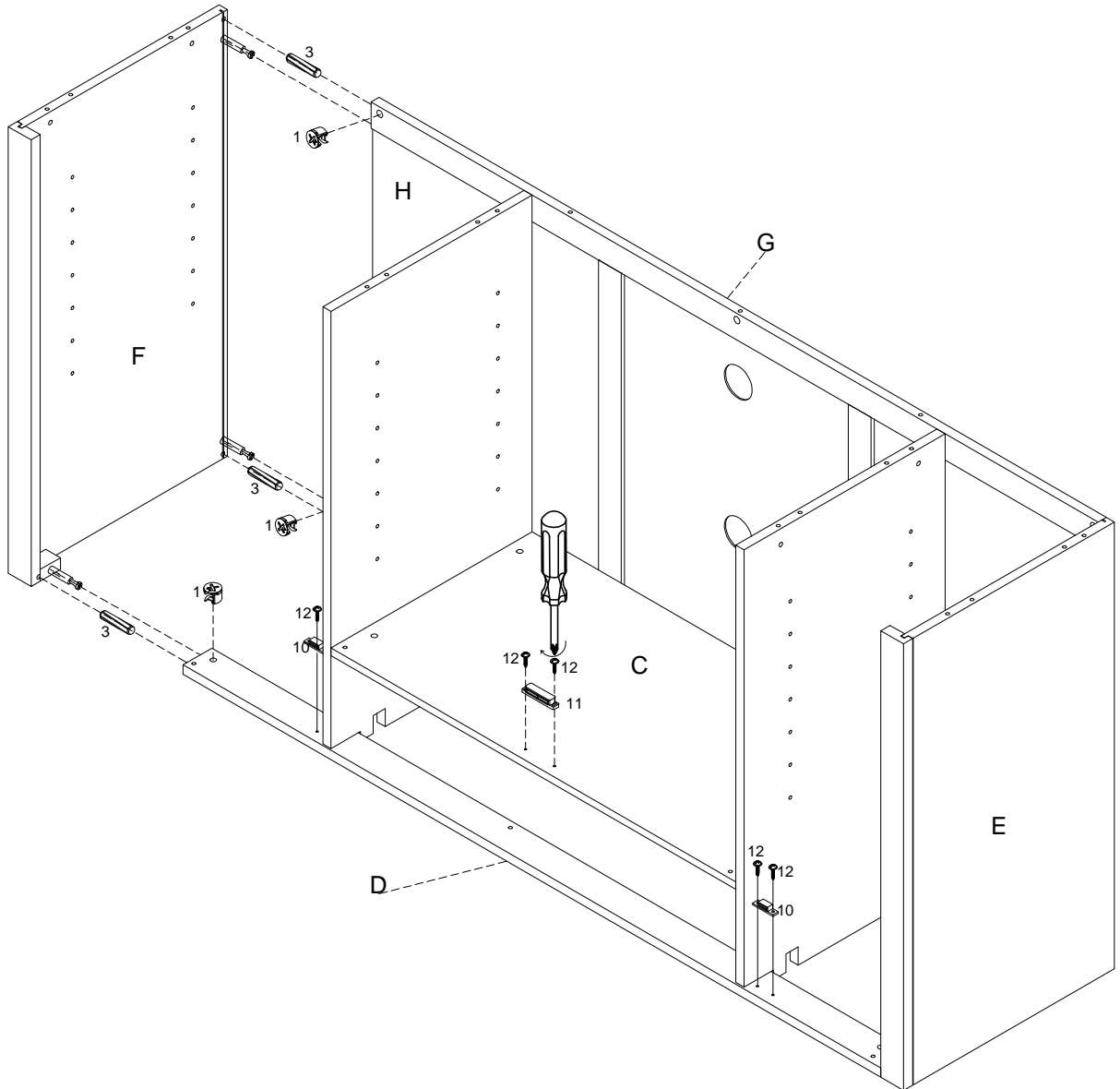





Step 7. Attach Side Panel F using Wood dowels & Cam locks as shown. Attach Magnet (part #11) to Shelf C using Round Head screws (Part#12) as shown. Attach Door Catch Magnet (Part#10) to Rail D using Round Head Screws (Part #12) as shown.

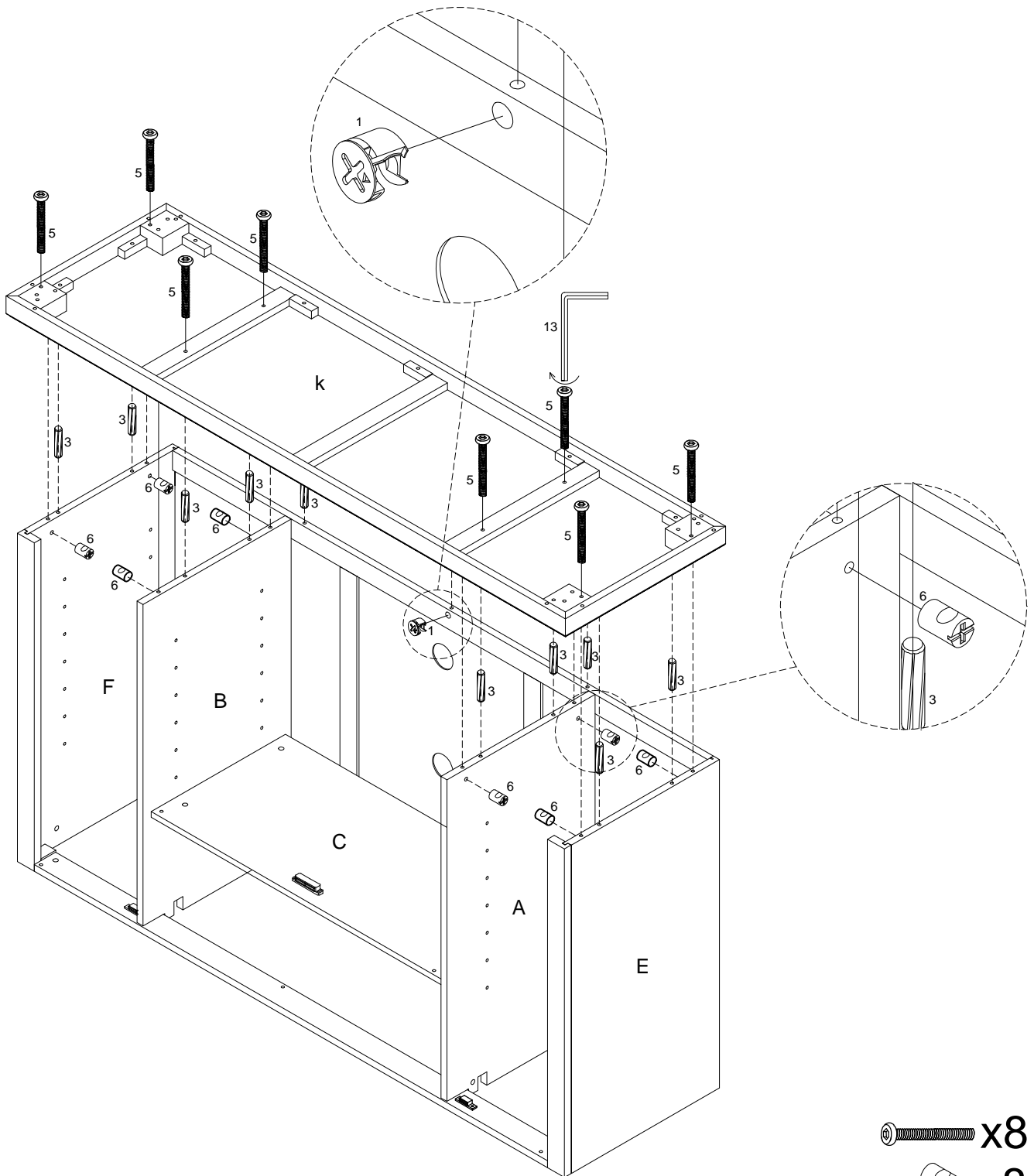

-  x1
-  x2
-  x6
-  x3
-  x3



Step 8. With bottom side facing up, attach Base K to cabinet using Wood Dowels, Hex Socket Head Bolt (Part #5) & Barrel Nuts (Part #6) as shown. Attach legs using Hex Socket Head Bolts & Wood dowels (as shown in instruction manual included in carton with legs). **IMPORTANT!-DO NOT ATTACH THE CENTER SUPPORT LEG AT THIS TIME.** Carefully turn cabinet over so that Base K is now on the bottom



-  x8
-  x8
-  x1
-  x10

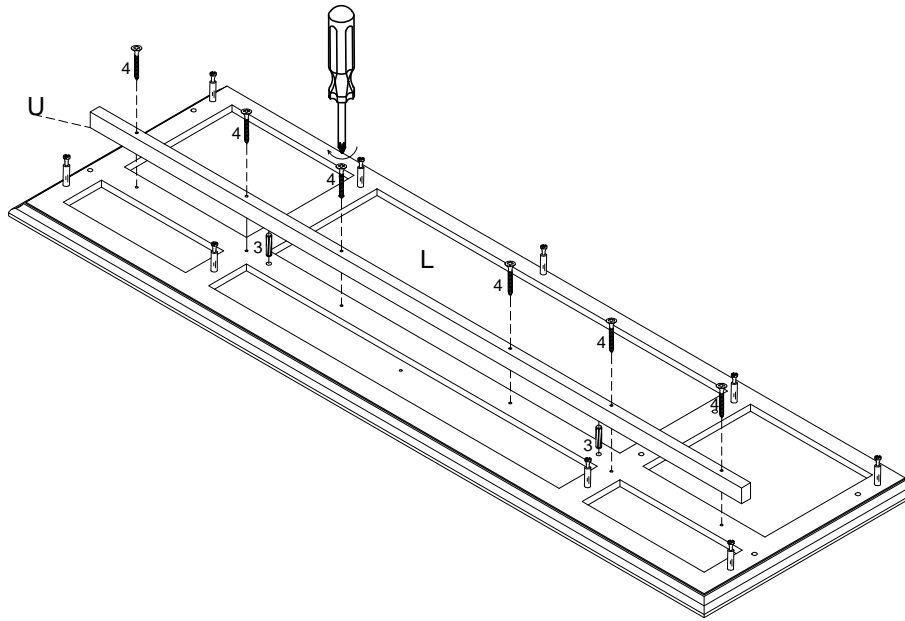

Step 9. Attach Rail U to Top L using Wood Dowels & Screws as shown.

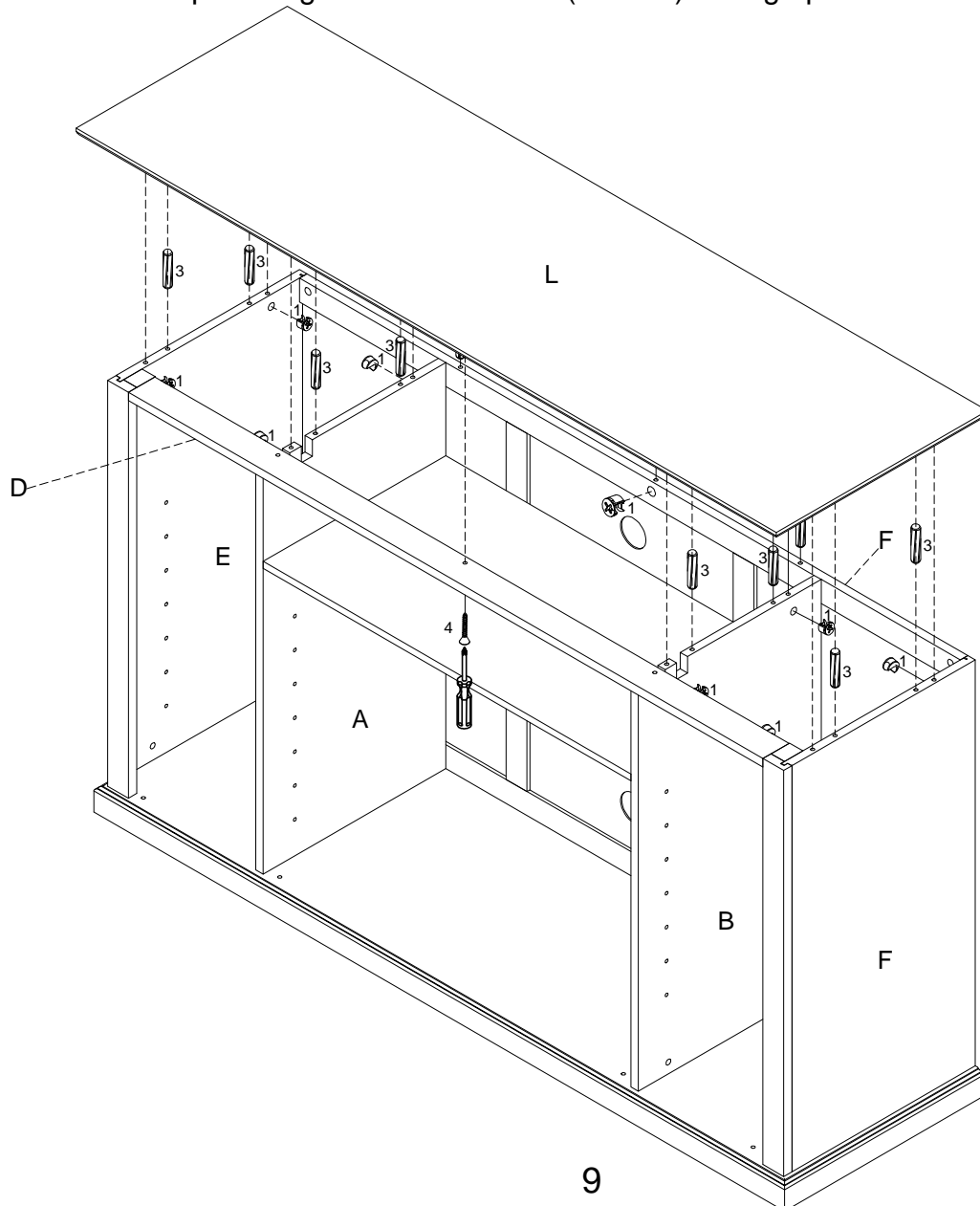

 x2
 x6

Step 10. Attach Top L to cabinet using Wood Dowels & Cam Locks as shown. Secure Rail D to Top L using one Wood Screw (Part #4) through pre-drilled hole as shown.



 x1
 x9
 x10

Step 11. Attach hardware knobs (Part #8) to Doors M,N,O&P using Round Head Bolts (Part #9) and a Phillips Head screw driver. Attach doors to cabinet by placing bottom Pin Hinge into pre-drilled holes at the bottom & depressing top spring loaded Pin Hinge to fit door into place. Note: Be sure Pin Hinges (top &bottom) have fully extended into the pre-drilled holes to secure doors into place.

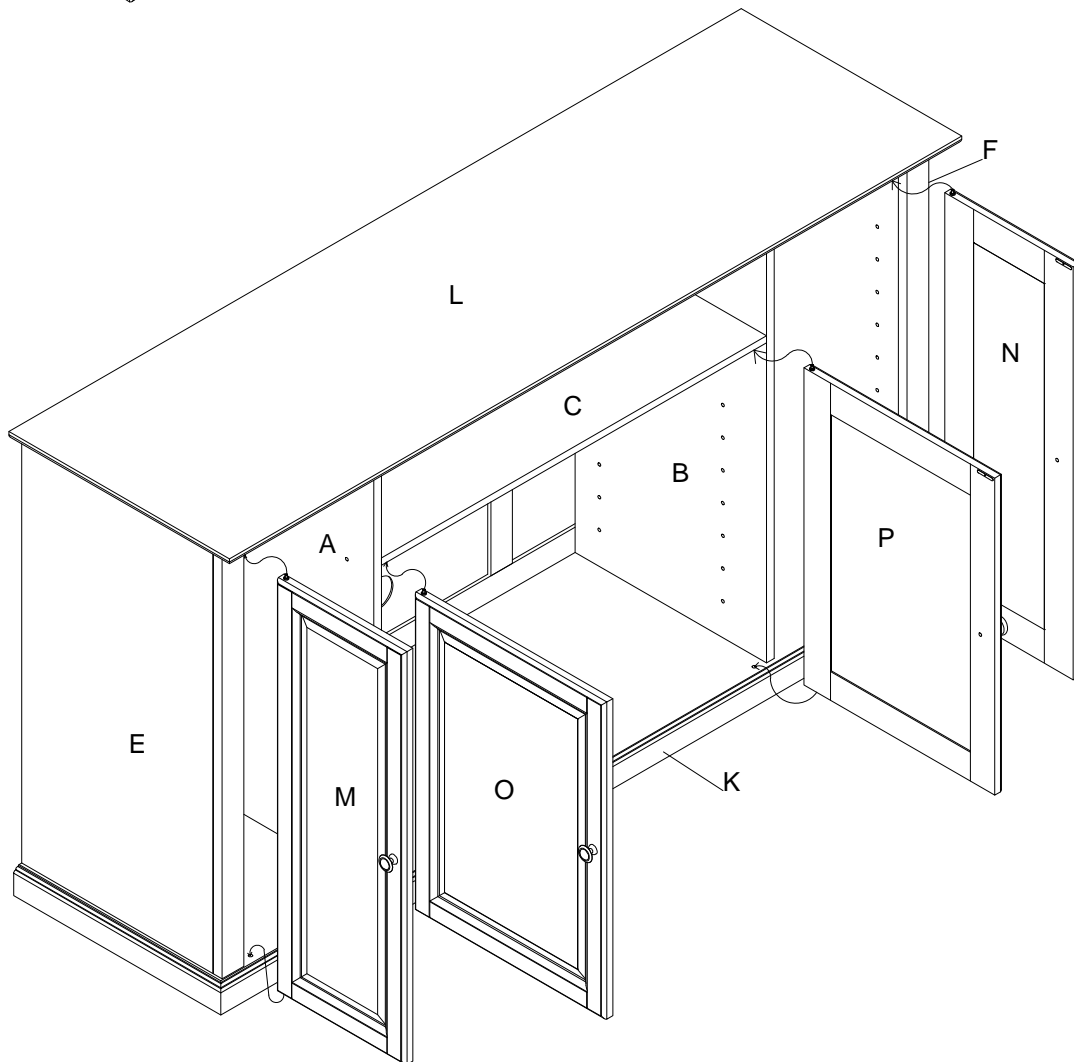
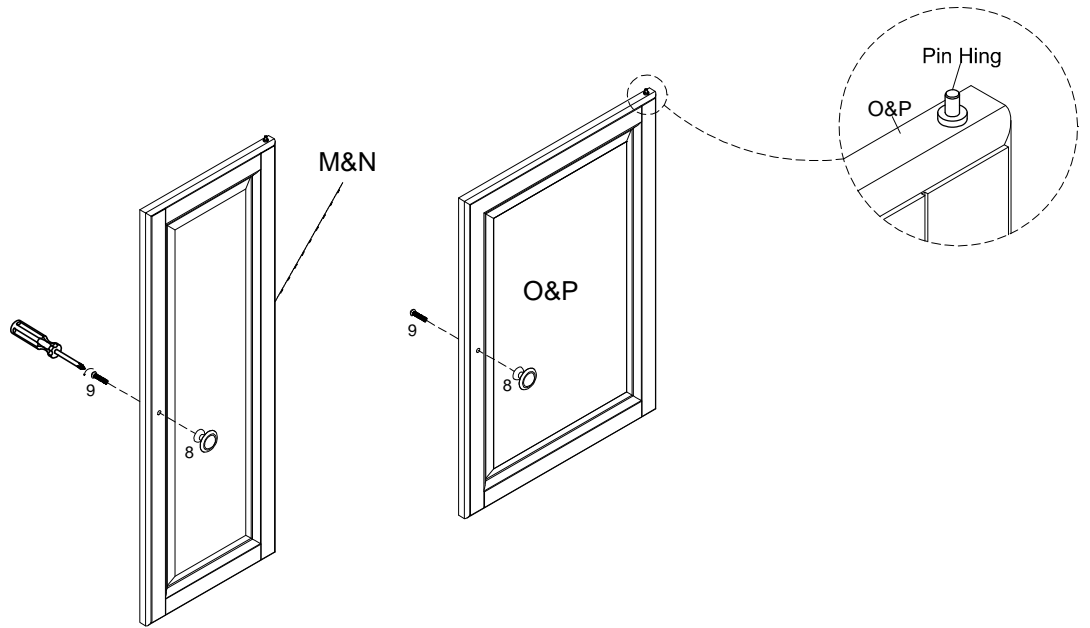

Step 12. Insert the Shelf Holders (Part #7) into desired position and add shelves.

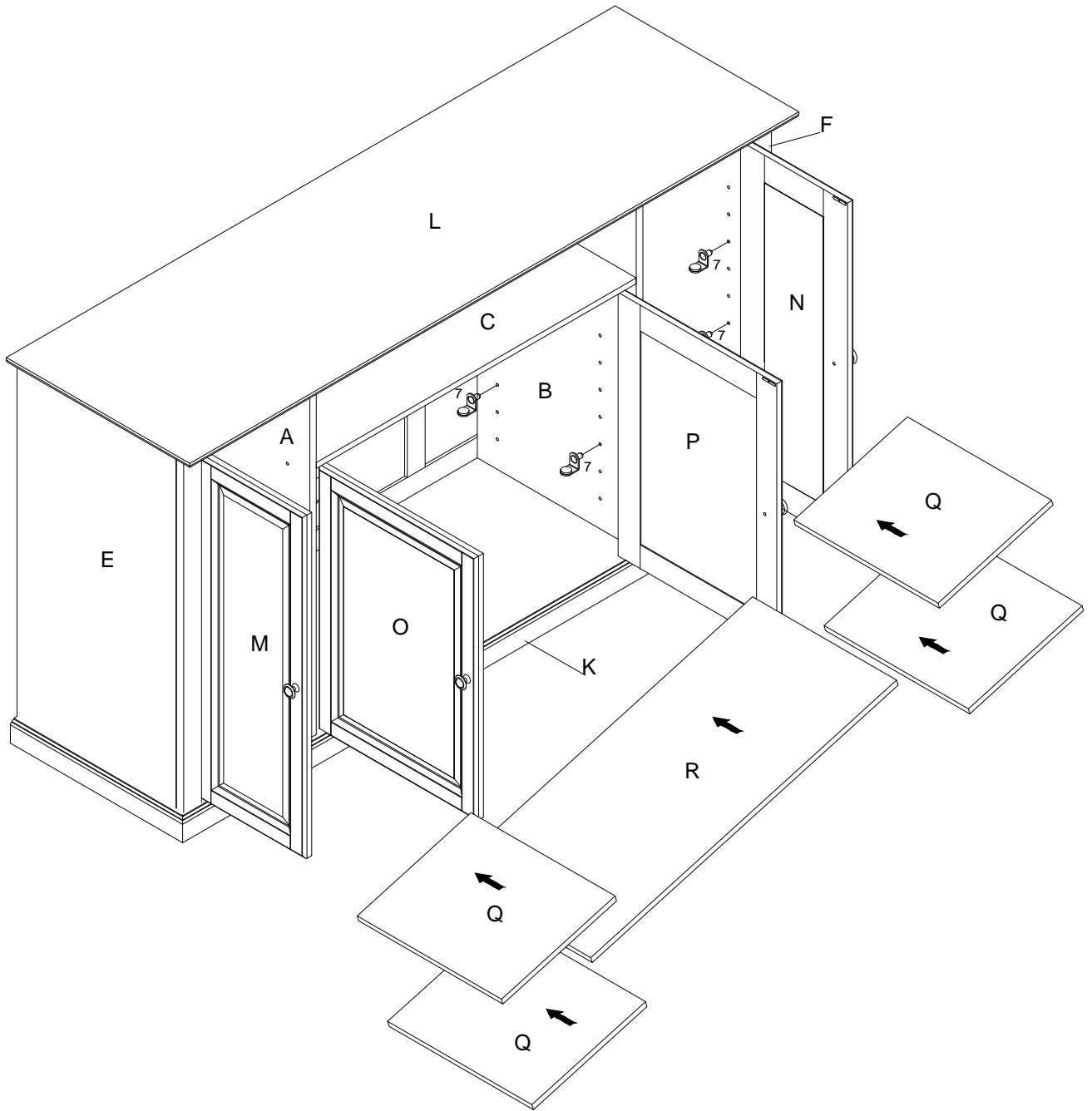

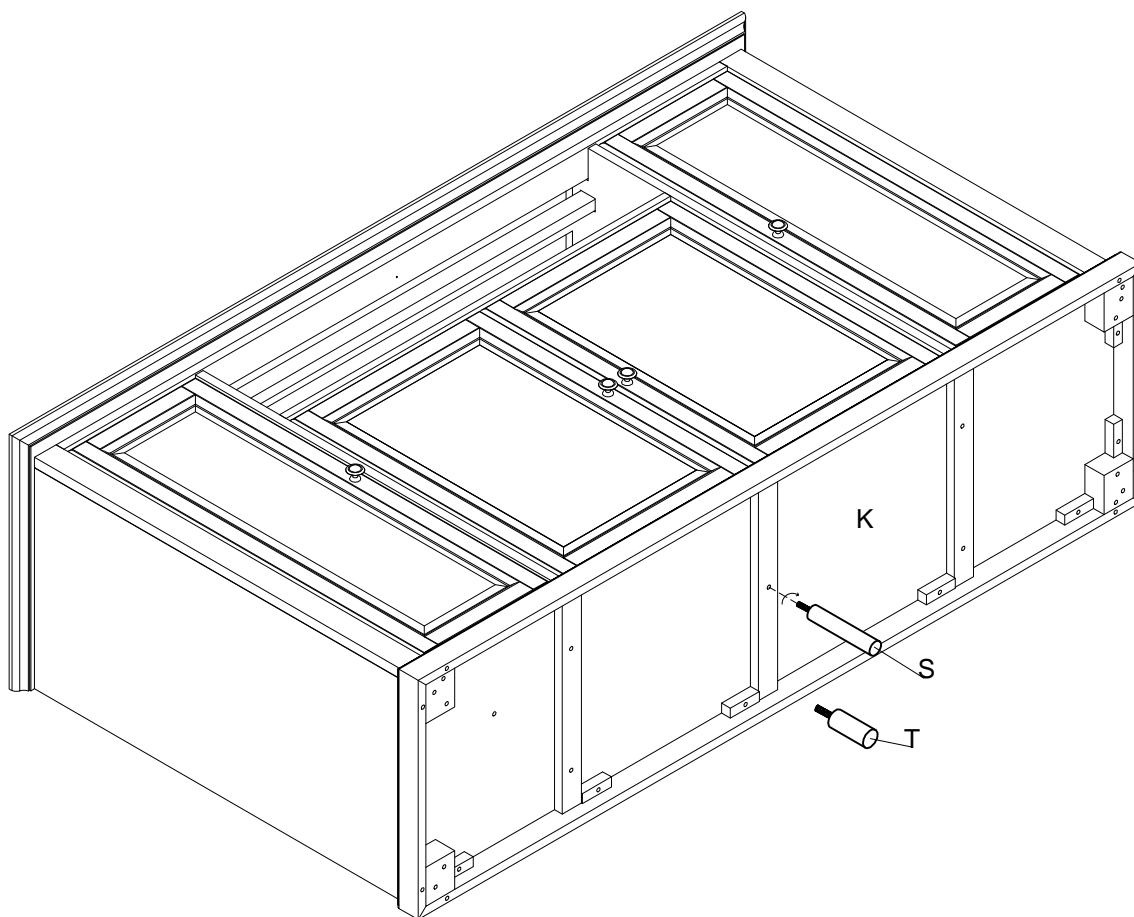

Step 13. Place your assembled cabinet into the desired spot in your home. Attach the Center Support Leg S or T now by turning clockwise into the pre-drilled hole. Support Leg T is for use only with Bun Foot. All other Leg styles will use support leg S. **NOTE:** The adjustable leveler on the bottom of the Center Support Leg S/T should not be extended until after installation. Adjust the leveler on the bottom of the Center Support leg S/T until it fits tightly against the floor.

IMPORTANT!-IF YOU WISH TO RELOCATE YOUR CABINET, BE SURE TO REMOVE THE CENTER SUPPORT LEG. RE-INSTALL AFTER THE CABINET HAS BEEN MOVED.

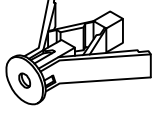

Step 14.

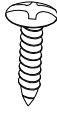
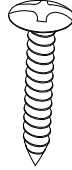
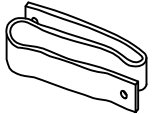
14	A	B	C	D	E
					
SAFETY STRAP KIT 1 SET	WALL ANCHOR AX1 PC	WASHER BX2 PCS	SHORT SCREW CX1 PC D8*3/4"	LONG SCREW DX1 PC D8*1-1/2	SAFETY WALL STRAP EX1 PC

SAFETY WALL STRAP ASSEMBLY INSTRUCTION

1). Insert Short Screw(Part#C) through Washer(Part#B) and Safty Wall Starp(Part#E) and screw it into Parts L.

2. Drill a 9mm hole at a point where you want to secure/attach your TV stand cabinet. Make sure that the height of the hole being drilled into the wall is equal to the height of the hole in Part L. Tap Wall Anchor (Part#A) into the hole.

3. Insert Long Screw (Part#D) through a Washer (Part#B) and Wall Safty Strap (Part#E) into Wall Anchor (Part#A).

Note: This item is not intended for clothing storage use.

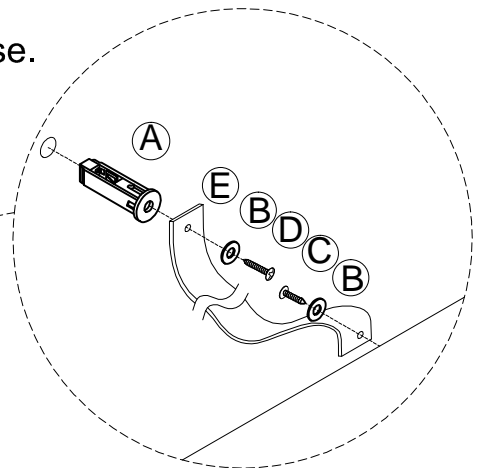
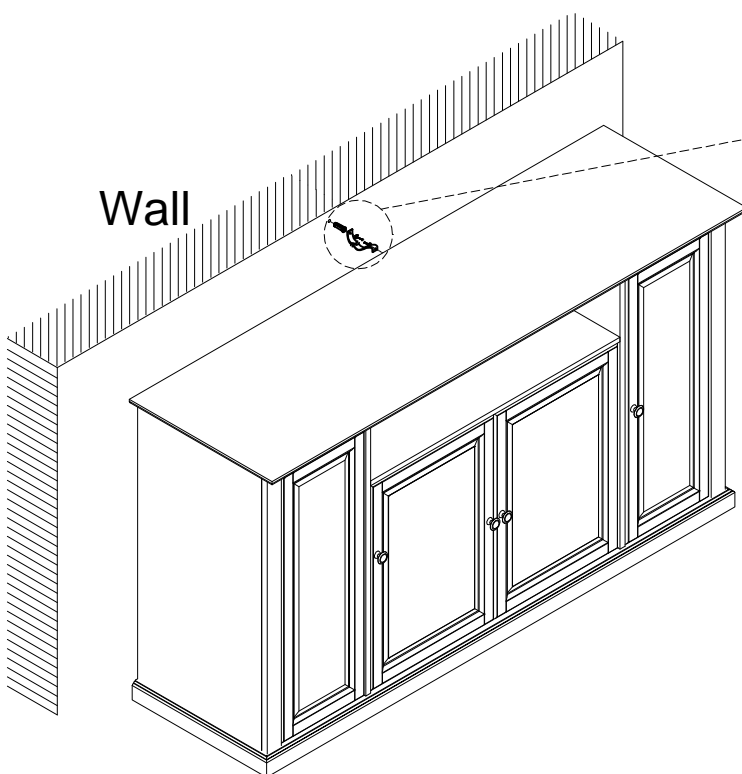

⚠ WARNING

Children have died from furniture tipover.

To reduce the risk of furniture tipover:

- ALWAYS install tipover restraint provided.
- For use with televisions weighing 50lbs(23kgs) or less. Use with heavier television may result in instability causing tip-over resulting in death or serious injury.
- NEVER allow children to stand, climb or hang on drawers, doors, or shelves.
- NEVER open more than one drawer at a time.
- Place heaviest items in the lowest drawers.

This is a permanent label. Do not remove!